

# ambit

design  
Giovanni Levanti, 2020



1040

- > Sistema sedute multiple. Sedile e schienale imbottiti. Piedi in fusione alluminio. Modulo lineare L 80 cm, schienale H 76 cm.
- > Modular seating system. Upholstered seat and back. Feet in cast aluminium. Linear module L 80 cm, backrest H 76 cm.



1041

- > Sistema sedute multiple. Sedile e schienale imbottiti. Piedi in fusione alluminio. Modulo lineare L 80 cm, schienale H 126 cm.
- > Modular seating system. Upholstered seat and back. Feet in cast aluminium. Linear module L 80 cm, backrest H 126 cm.



1045

- > Sistema sedute multiple. Sedile e schienale imbottiti. Piedi in fusione alluminio. Modulo lineare L 80 cm, schienale H 76 cm. Versione bifacciale.
- > Modular seating system. Upholstered seat and back. Feet in cast aluminium. Linear module L 80 cm, backrest H 76 cm. Double-sided version.



1046

- > Sistema sedute multiple. Sedile e schienale imbottiti. Piedi in fusione alluminio. Modulo lineare L 80 cm, schienale H 126 cm. Versione bifacciale.
- > Modular seating system. Upholstered seat and back. Feet in cast aluminium. Linear module L 80 cm, backrest H 126 cm. Double-sided version.

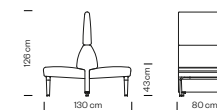
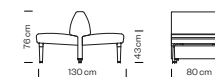
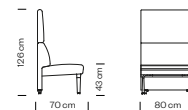



04



05



1047

- > Sistema sedute multiple. Sedile e schienale imbottiti. Piedi in fusione alluminio. Modulo lineare L 80 cm, schienale H 98 cm. Versione bifacciale.
- > Modular seating system. Upholstered seat and back. Feet in cast aluminium. Linear module L 80 cm, backrest H 98 cm. Double-sided version.



1050

- > Sistema sedute multiple. Sedile e schienale imbottiti. Piedi in fusione alluminio. Modulo lineare seduta L 120 cm e schienale L 80 cm, schienale H 76 cm.
- > Modular seating system. Upholstered seat and back. Feet in cast aluminium. Linear module seat L 120 cm and backrest L 80 cm, backrest H 76 cm.



1051

- > Sistema sedute multiple. Sedile e schienale imbottiti. Piedi in fusione alluminio. Modulo lineare seduta L 120 cm e schienale L 80 cm, schienale H 126 cm.
- > Modular seating system. Upholstered seat and back. Feet in cast aluminium. Linear module seat L 120 cm and backrest L 80 cm, backrest H 126 cm.



1055

- > Sistema sedute multiple. Sedile e schienale imbottiti. Piedi in fusione alluminio. Modulo lineare seduta L 120 cm e schienale L 80 cm, schienale H 76 cm. Versione bifacciale.
- > Modular seating system. Upholstered seat and back. Feet in cast aluminium. Linear module seat L 120 cm and backrest L 80 cm, backrest H 76 cm. Double-sided version.



1056

- > Sistema sedute multiple. Sedile e schienale imbottiti. Piedi in fusione alluminio. Modulo lineare seduta L 120 cm e schienale L 80 cm, schienale H 126 cm. Versione bifacciale.
- > Modular seating system. Upholstered seat and back. Feet in cast aluminium. Linear module seat L 120 cm and backrest L 80 cm, backrest H 126 cm. Double-sided version.



1057

- > Sistema sedute multiple. Sedile e schienale imbottiti. Piedi in fusione alluminio. Modulo lineare seduta L 120 cm e schienale L 80 cm, schienale H 98 cm. Versione bifacciale.
- > Modular seating system. Upholstered seat and back. Feet in cast aluminium. Linear module seat L 120 cm and backrest L 80 cm, backrest H 98 cm. Double-sided version.



1060

- > Sistema sedute multiple. Sedile e schienale imbottiti. Piedi in fusione alluminio. Modulo lineare L 120 cm, schienale H 76 cm.
- > Modular seating system. Upholstered seat and back. Feet in cast aluminium. Linear module L 120 cm, backrest H 76 cm.



1061

- > Sistema sedute multiple. Sedile e schienale imbottiti. Piedi in fusione alluminio. Modulo lineare L 120 cm, schienale H 126 cm.
- > Modular seating system. Upholstered seat and back. Feet in cast aluminium. Linear module L 120 cm, backrest H 126 cm.

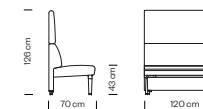
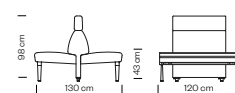
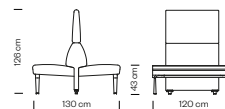
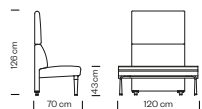
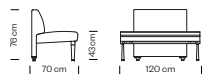
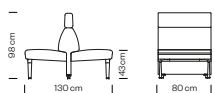





1065

- > Sistema sedute multiple. Sedile e schienale imbottiti. Piedi in fusione alluminio. Modulo lineare L 120 cm, schienale H 76 cm. Versione bifacciale.
- > Modular seating system. Upholstered seat and back. Feet in cast aluminium. Linear module L 120 cm, backrest H 76 cm. Double-sided version.



1066

- > Sistema sedute multiple. Sedile e schienale imbottiti. Piedi in fusione alluminio. Modulo lineare L 120 cm, schienale H 126 cm. Versione bifacciale.
- > Modular seating system. Upholstered seat and back. Feet in cast aluminium. Linear module L 120 cm, backrest H 126 cm. Double-sided version.



1067

- > Sistema sedute multiple. Sedile e schienale imbottiti. Piedi in fusione alluminio. Modulo lineare L 120 cm, schienale H 98 cm. Versione bifacciale.
- > Modular seating system. Upholstered seat and back. Feet in cast aluminium. Linear module L 120 cm, backrest H 98 cm. Double-sided version.



1070

- > Sistema sedute multiple. Sedile imbottito. Piedi in fusione alluminio. Modulo lineare L 120 cm.
- > Modular seating system. Upholstered seat. Feet in cast aluminium. Linear module L 120 cm.



1071

- > Sistema sedute multiple. Sedile imbottito. Piedi in fusione alluminio. Modulo lineare L 120 cm. Versione bifacciale.
- > Modular seating system. Upholstered seat. Feet in cast aluminium. Linear module L 120 cm. Double-sided version.



1075

- > Sistema sedute multiple. Tavolino per composizione lineare. Piedi in fusione alluminio.
- > Modular seating system. Coffee table for linear composition. Feet in cast aluminium.



1076

- > Sistema sedute multiple. Tavolino per composizione angolare. Piedi in fusione alluminio.
- > Modular seating system. Coffee table for corner composition. Feet in cast aluminium.



1077

- > Sistema sedute multiple. Tavolino per composizione lineare. Piedi in fusione alluminio. Versione bifacciale.
- > Modular seating system. Coffee table for linear composition. Feet in cast aluminium. Double-sided version.

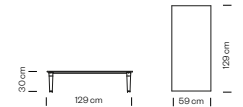
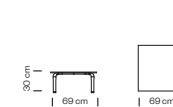
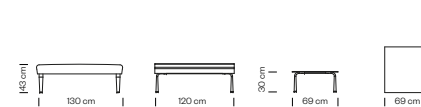
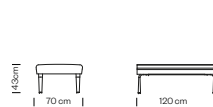
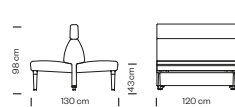
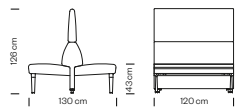
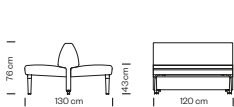

accessori / accessories



- > Presa di corrente sul piano del tavolino.
- > Power socket on the table top.



- > Presa usb per sedute imbottite e tavolini.
- > USB socket for upholstered seats and tables.





## TE

- > Finiture seduta  
(vedi catalogo)
- > Seat finishes  
(see catalogue)

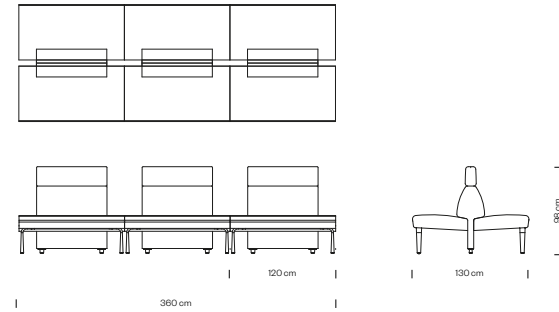
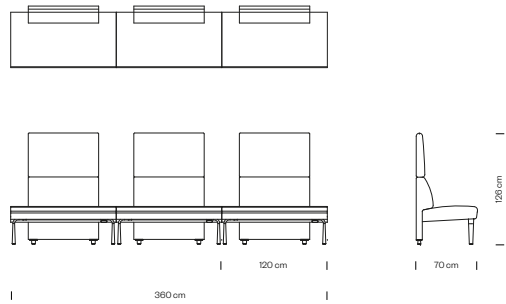

## AL VR

- > Finiture telaio  
(vedi catalogo)
- > Frame finishes  
(see catalogue)

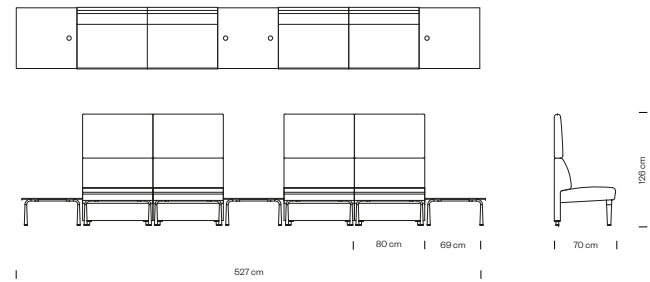
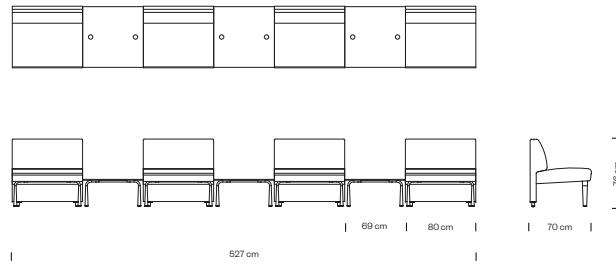

## STR

- > Finiture piani tavoli  
(vedi catalogo)
- > Table tops finishes

